

**Epson SureColor®
F10030/F10030H Dye-
Sublimation Textile Printer**

Sales Reference Guide

**GO
BIG
ON TEXTILES.**

Epson Dye-Sublimation Printer Lineup

24" DYE-SUB PRINTER

Easy-to-use, Compact, High Print Quality



F530 / F531

44" DYE-SUB PRINTER

High image quality, Fast, Reliable



F6330

64" DYE-SUB PRINTER

Wider print width with roll to roll capability



F7270



F9430/F9430H

76" DYE-SUB PRINTER

Industrial-like, developed for high production textile market



F10030



F10030H

Full Dye-sub printer lineup to allow Business Scalability and Job Flexibility



SC-F10030/F10030H Product Overview



SC-F10030/F10030H Product Overview

Epson's **first 76" Large Format Printer** in more than 10 years of Epson's LFP history



GO BIG

Product image is for SC-F10030

SC-F10030/F10030H Product Overview



Product image is for SC-F10030

SC-F10030/F10030H Product Overview

New PrecisionCore
Micro TFP Print Heads

Inside LED light

Anti-drying Cap

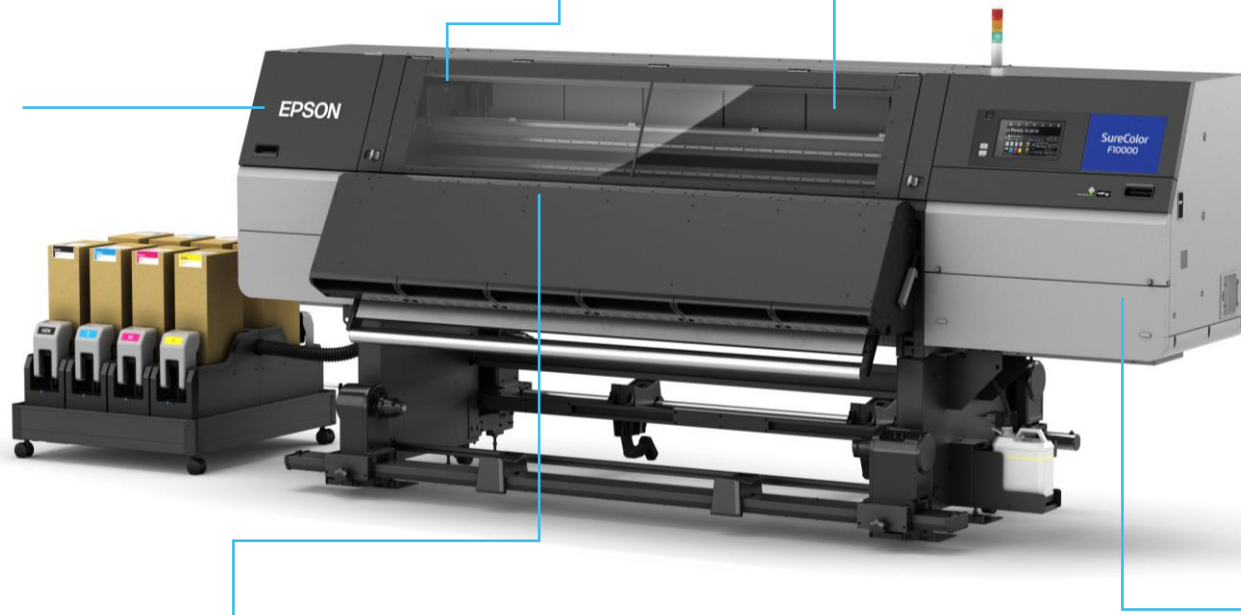

75" width platen

Wide width
wiper unit

Product image is for SC-F10030



Epson PrecisionCore™ Technology |

Epson PrecisionCore™ Technology

- **Extreme Print Quality**
 - Print resolutions up to 1,200 x 1200 dpi for amazing quality
 - Precision dot control for outstanding clarity and sharpness for textile and garment printing

- **Fast Print Speeds**
 - 3,200 nozzles per head
 - Quite possible one of the fastest dye-sublimation transfer printers in its class

- **Commercial-Grade Reliability**
 - Ideal for printing with dye-sublimation ink chemistry
 - Co-developed with Epson UltraChrome DS ink technology for extreme reliability
 - Capable of very high production, with little downtime





Epson UltraChrome® DS Ink

Epson UltraChrome® DS Ink

- **Developed Specifically for Epson PrecisionCore TFP Print Head**
 - Significantly increases overall print head life
 - The SureColor F-series printers are designed to be used exclusively with Epson UltraChrome DS inks for reliable performance and high image quality
- **High Density Black**
 - High efficiency ink formulated to achieve dramatic color intensity and high color contrast
 - Superior overall image quality – both image definition and text sharpness are amazing
- **Safety First**
 - Epson UltraChrome DS inks are Eco Passport certified by Oeko-Tex. This is an international safety standard in the textile industry. It is certified to be safe for adults and children, including babies.
 - Epson UltraChrome DS inks are AZO certified to be free of aryl amines





Key Product Features

New PrecisionCore Micro TFP Printhead

- **4.7 inch** bandwidth
- Total number of nozzles is **3,200** per head (800 * 4 chips)
- Head resolution is **600dpi** (300dpi * 2 lines)
- SC-F10030 comes with **4 Micro TFP Printheads**;
SC-F10030H comes with **6 Micro TFP Printheads**

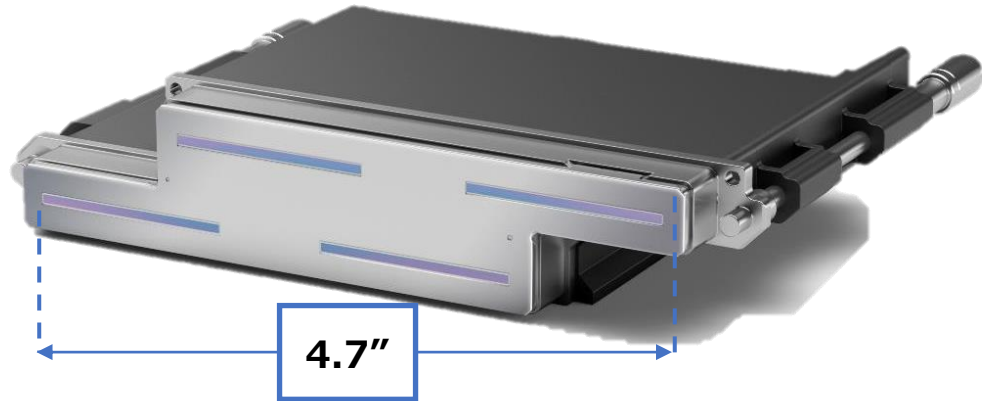

Epson Micro Piezo Technology introduction

https://global.epson.com/innovation/core_technology/inkjet/micro_piezo.html

Technical Data

https://global.epson.com/innovation/core_technology/pdf/precisioncore.pdf

New Dryer

- High efficiency of new dryer realizes high speed printing with **less ink transfer to media backside** and **less heavy wrinkle** after printing
- Paper surface temperature controlled effectively by frontside heater with fan and backside heater



Enhanced Epson Precision Dot Technology

- New halftone realizes higher printing robustness against dot placement error.
- Basic idea of new halftone is to put halftoning multiple times like one layer and another layer.
- It's "**Multi-layer Half Tone**".

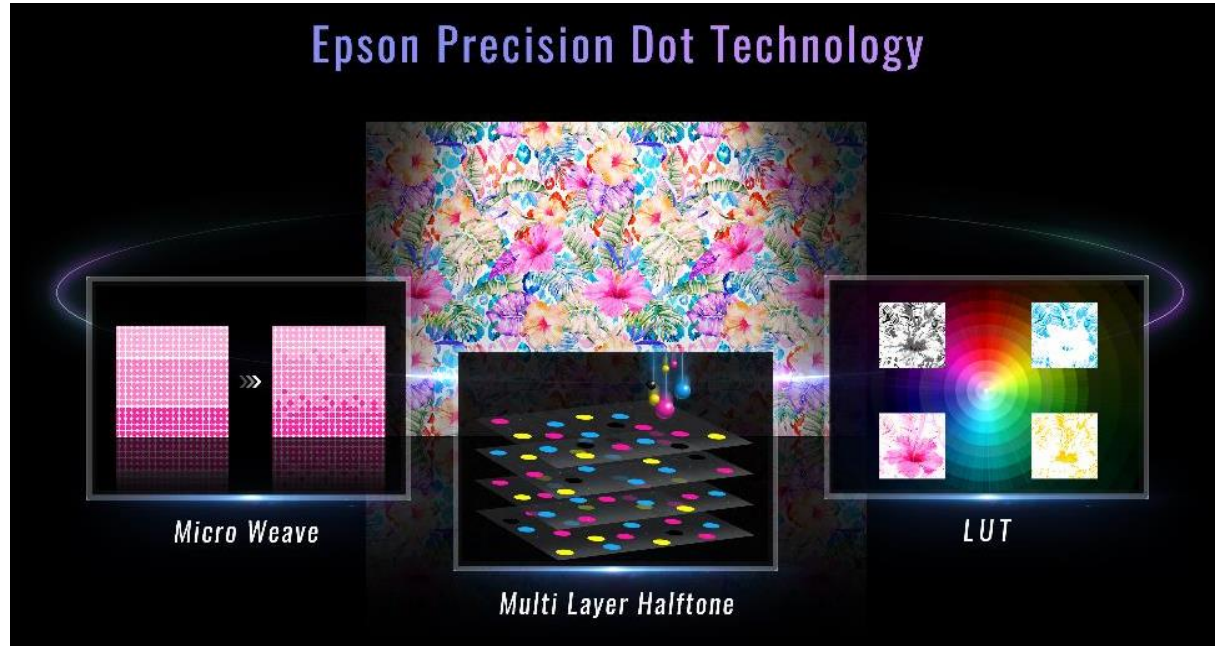

Bulk Ink System with Hot Swap Function

- Continuous operation, is realized by bulk ink supply system with 10L ink cartridges and **hot swap function** :
 - If one ink cartridge is used up during printing, the printer automatically switches and activates the other cartridge and continue printing
 - Finished ink cartridge can be replaced with new ink cartridge while printing on new ink cartridge



Ink cartridge image is for SC-F10030H

Step & Repeat on Printer

- PC can be released from data spooling as printer can perform step & repeat print independently from PC, improving productivity with **faster transfer speed**
- Users can select this function on RIP software by setting print size

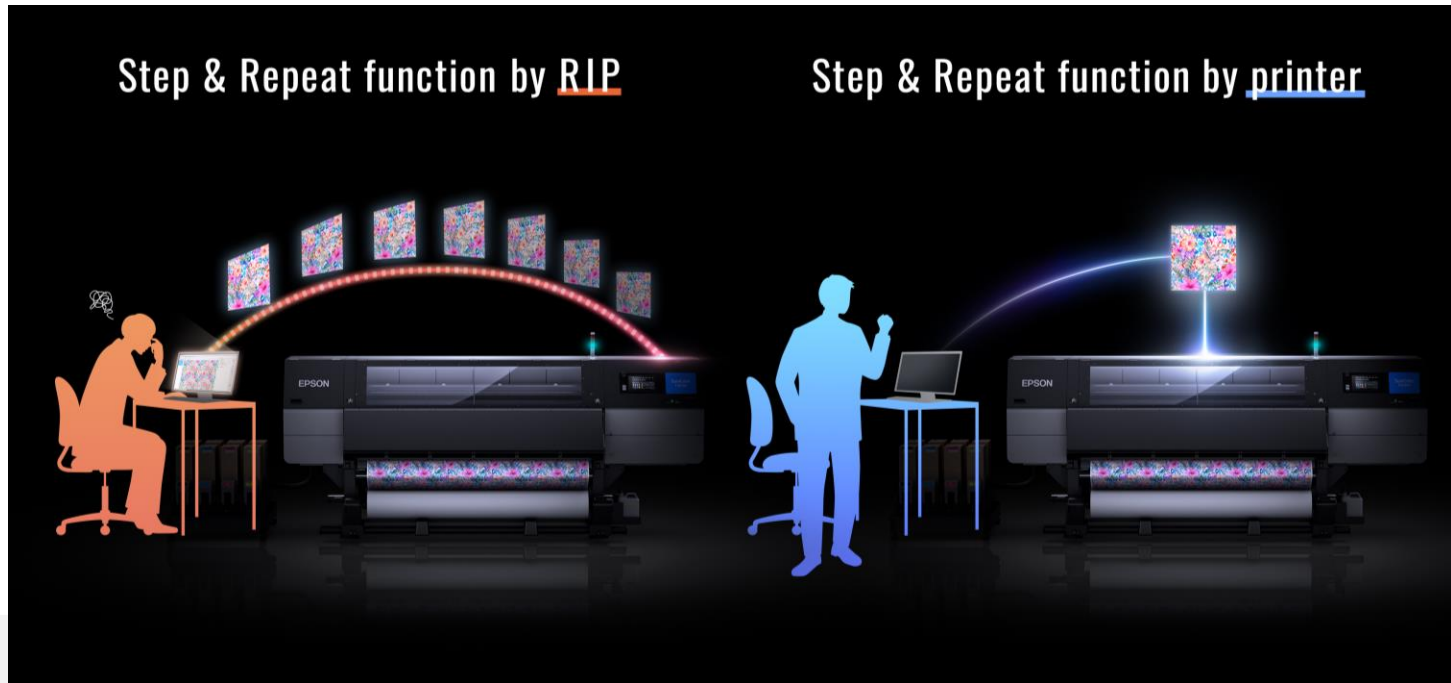

User Self-Repair Function

- **Downtime is minimized** with the introduction of User Self-Repair function. Specific parts such as print head can be replaced by users themselves, so that there is **faster recovery** from printer down time status.
- User Self-Repair function is supported by :
 - Printer Diagnosis System
 - Easy replaceable print head and anti-drying cap
 - Epson Remote Monitoring System

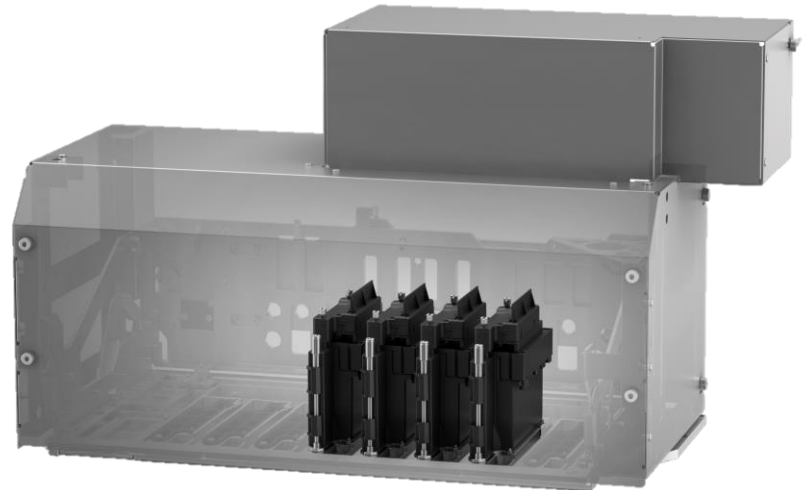



Value Proposition





1 year Self-Repair
Warranty



SC-F10030 / F10030H Printer



Epson PrecisionCore™ Micro TFP
print head technology

User Self-Repair
Printheads

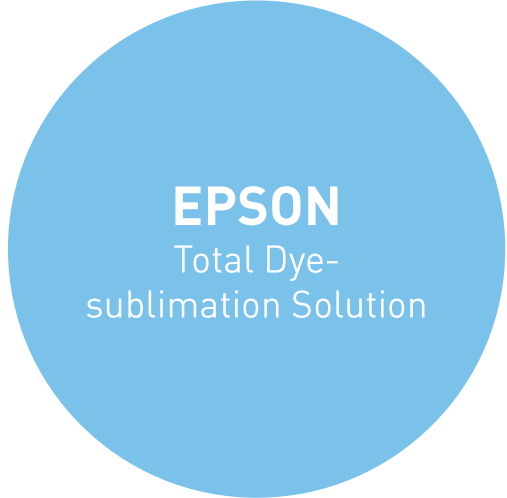

Epson Edge Print



Epson Cloud Solution Port

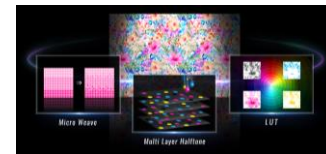

Epson Precision Dot Technology



UltraChrome DS Bulk
Ink System

Epson Cloud Solution

PORT

Epson Cloud Solution Port

Epson Cloud Solution PORT is a **cloud-based solution** for Epson's end user. This software allows users to check the status of the connected printer through the production monitor and troubleshoot easily if required.

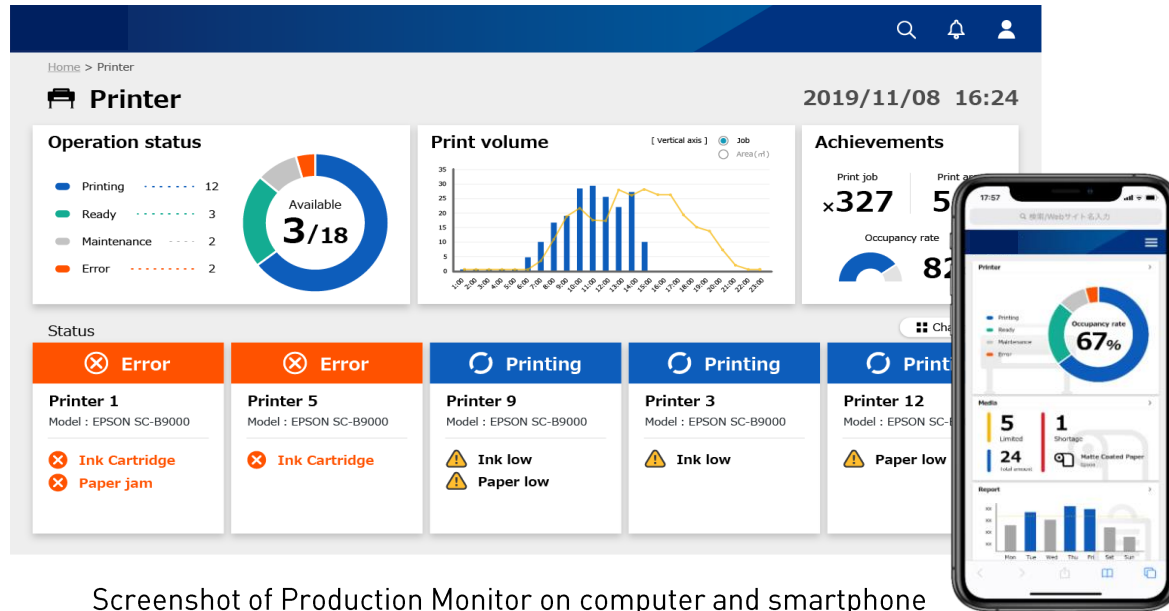

Screenshot of Production Monitor on computer and smartphone

Benefits of Epson Cloud Solution Port includes :

- 01 Reduction in business loss with less downtime due to printhead failure
- 02 Visualize your printer's operational status anytime, anywhere
- 03 Accurate failure diagnosis and prompt responses to inquiries by Epson

Value Proposition

Industrial-Level Production Speeds

- Outstanding everyday production speeds
- Dramatically reduces the number of printers needed for full production capacity

Designed for High Reliability

- Print head and ink technology developed to work together for improved reliability
- Developed to be a dye-sublimation solution -not a 'hacked' Epson photo printer

High Image Quality

- Epson UltraChrome DS with HDK ink technology produces amazing color with rich blacks
- Capable of producing true photographic output with smooth tonal transitions

Minimize Downtime

- Reduce business loss with self-replaceable print heads and printer diagnosis system

Completely Supported by Epson

- World class service and support directly from one source
- Accurate failure diagnosis and prompt responses to inquiries with Epson Cloud Solution Port

**IT'S
TIME TO
GO BIG.**

EPSON
EXCEED YOUR VISION